

WINDOWS • PATIO DOORS • ENTRY DOORS

www.windowcity.com

COLLECTION 2016 | 2017

WINDOWCITY

Engineered for Quality, Designed for Style



More choices. Greater selection. One source.

More choices.
Greater selection.
One source.



INDEX

Manufacturing	1
Solar Solutions	2 - 3
Heritage Collection	4 - 7
Heritage Plus Collection	8 - 9
Heritage Maximum Collection	10 - 11
Classic Collection	12 - 19
Bay & Bow Windows	20
Architectural Shapes	21
Trim Options	22
Grille Options	23
Ultra Patio Door Sliding Collection	24 - 25
Ultra Patio Door Swing Collection	26 - 27
Lifetime Entry Door Collection	28
Classic Entry Door Collection	29
Elegance Entry Door Series	30
Citadel Entry Door Series	31 - 32
Castle Gate Entry Door Series	33
Citadel Premium Series	34 - 35
Decorative Glass Collection	36 - 45
Commodity Glass Collection	46
Paint & Stain Options	47
Window Hardware Options	48
Door Hardware Options	49



COMPANY PROFILE

Since 1992 Window City has built an organization that has become a leader in the extruding and manufacturing of vinyl windows and doors and now we have added the most unique entry door system unmatched in the industry today. Window City is recognized throughout North America for our design excellence, precision craftsmanship and state of the art technology necessary to produce windows and doors that meet the industry's demanding performance standards. By combining our fully automated window manufacturing capabilities with the latest door technology, Window City has the solutions to all your window and door requirements. Both of our Lifetime Entry Door Collection and Classic Entry Door Collection are truly unique door systems that offer full customization choices from size to frames and hardware, several paint and stain colours and an extensive glass selection. We offer one of the most complete energy efficient products in the industry. Our Solar Solutions glass options are Energy Star™ certified and allow the homeowner the opportunity to customize the comfort, security and performance of every room in their home based on where they live. We are proud of our reputation within the window and door industry. Dealers, builders, architects and remodelers enjoy working with our vast range of products, multiple accessory and option choices plus extensive services and they all rely on Window City's commitment to excellence.

We consider our comprehensive knowledge of the window and door industry to be one of our greatest strengths. We know the vinyl extrusion process, glass technology, home construction and the renovation industry. This knowledge and in-depth awareness enables us to understand and deliver the products that are needed today, even while we are researching and designing for tomorrow.



COMPOUNDING

Window City manufactures its own PVC compound made from top quality resin. This allows us to control the quality and consistency necessary to provide some of the most advanced extrusions in the marketplace today.

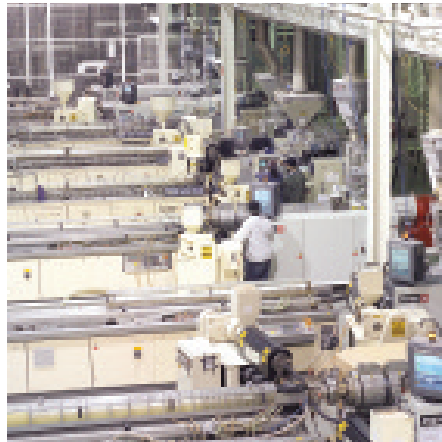

EXTRUSIONS

We design and extrude all of our window profiles, making our products exclusive to Window City. Our commitment to quality starts with the aesthetic and structural components of our products and continues throughout our manufacturing process. The end result guarantees our products are one of a kind in the window and door industry and have set the standard for excellence.



AUTOMATED FABRICATION, WELDING AND CLEANING

Precision and quality are the standard for all Window City products. We leave nothing to chance during the manufacturing process. Our automated fabrication centers provide precision cutting and fabrication of the frames, sashes and accessories. Automated 4 point welders and cleaners ensure this consistency throughout the entire product collection, regardless of the size or configuration of your windows or doors.



INSULATED GLASS UNITS

Window City manufactures all of its own insulated glass units resulting in consistent quality and the ability to offer several performance and security choices with Solar Solutions glass options. Our state of the art automated glass manufacturing system is designed to provide the highest quality sealed units each and every time. Our automated gas fill machines allows us to certify the Argon or Krypton gas fill for each sealed unit we produce.



SOLAR SOLUTIONS



ENERGY STAR® WINDOWS AND DOORS WILL MAKE A DIFFERENCE IN YOUR HOME.

Window City's Solar Solutions glass options provide you with several choices to maximize your energy savings. Whether you are concerned with heating or cooling costs we have you covered. Energy Star® certified products help prevent green house gasses and assist in the conservation of our natural resources. There are several determining factors when selecting a qualified product you need to consider your geographic location in North America because the requirements can vary. Window City authorizes each product with permanent labeling on the spacer bar within the glass and provides an additional government recognized label on the glass.

This commitment to quality goes even further when we apply our gas into the sealed units. The gas is applied right at the time of sealing the unit; this system is one of a kind and allows Window City to certify the gas content in each and every unit. This technology allows us to incorporate the most efficient warm edge system and offer several performance and safety options in our windows and doors.

LoE-180™

Window City has upgraded our glass with the latest technology, so when the weather turns frigid, LoE-180™ glass is the perfect cold weather remedy. It provides excellent insulating capability, blocking heat loss to the

outside and reflecting heat back into the room plus it allows the winter sun's heat to pass into the home. The dramatic improvement in comfort from windows with warm glass surfaces also means the relative humidity of the indoor air can be controlled and maintained properly. The better insulated the window glass, the warmer your room will be.

NEAT® NATURALLY CLEAN GLASS

Window City introduces Neat® naturally clean glass. It harnesses the sun's UV rays to loosen dirt so water can rinse it away, leaving windows virtually spotless. Your windows will stay cleaner longer and will clean easier.

Homeowners and builders will enjoy the effects that a little sun, rain and Neat glass brings to windows. Not only that, because Neat is applied to Window City's LoE® 180 coated glazings, homes stay cooler in the summer and warmer in the winter.

i89 GLASS

Window City introduces LoE-i89™ our new energy-saving surface coated glass. This new coating will be found on the inside surface (room side) where it reflects the escaping heat back into the room, lowering U-factors and meeting the toughest energy guidelines as well. Coupled with our LoE 180 and argon fill, this double pane unit delivers near triple pane performance. What's more, LoE-i89™ enhanced performance glass is easy to clean and there is no haze to mar the view allowing more light to come into the room.

SOLAR SOLUTION OPTIONS

DOUBLE PANE

Double strength glass is standard in our insulated units along with LoE 180 Neat® and Super Spacer. All units are certified and Energy Star compliant.

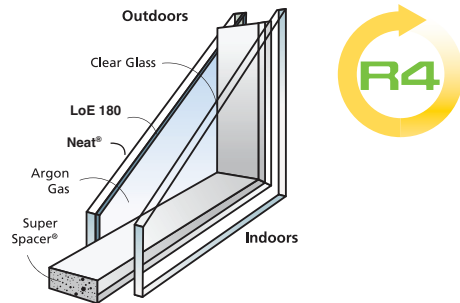

R4
LoE 180 Neat®, Argon with Super Spacer

LAMINATED GLASS

Tri-Pane Safe Vision™ laminated glass is produced by bonding a combination of plastic vinyl layers and polyester film between two panes of glass pressed into a single sheet. The pane of laminated glass completes the sealed unit. Laminated glass provides maximum safety from breakage, sound transmission and blocks 99% of damaging UV rays.

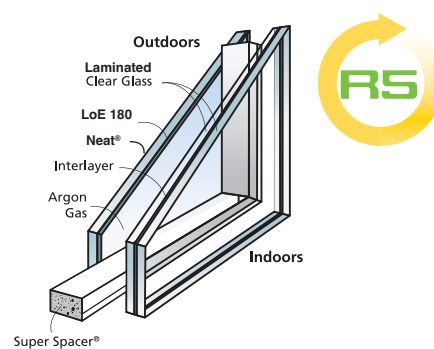

R5
Laminated, LoE 180 Neat®, Argon with Super Spacer

TRIPLE PANE

Triple pane consists of two lites of LoE 180 coated glass with an interior glass substrate, which creates two insulating chambers. These chambers can be filled with either argon (R6), an argon and krypton mix (R7.5) or krypton only (R9) gas. Triple pane will provide maximum R-values, reduced sound transmission and 95% UV blockage, all in one unit.

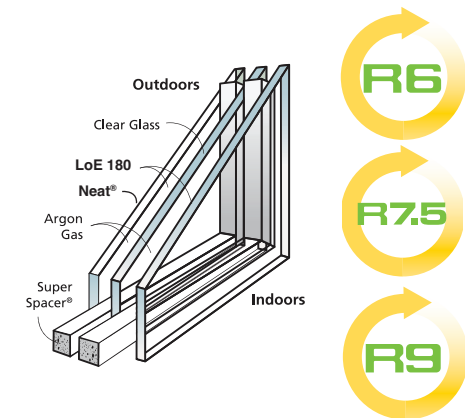

R6
Triple Pane, LoE 180 Neat®, Argon with Super Spacer

R7.5
Triple Pane, LoE 180 Neat®, 50% Argon/50% Krypton with Super Spacer

R9
Triple Pane, LoE 180 Neat®, Krypton with Super Spacer

DOUBLE PANE

Double strength glass is optional in our insulated units along with LoE 180 Neat® and i89 with Super Spacer and Argon gas filled. This units exceed Energy Star compliance.

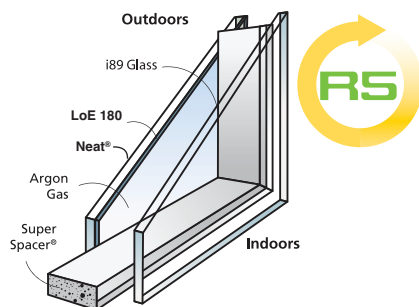

R5
LoE 180 Neat® with i89 Argon with Super Spacer

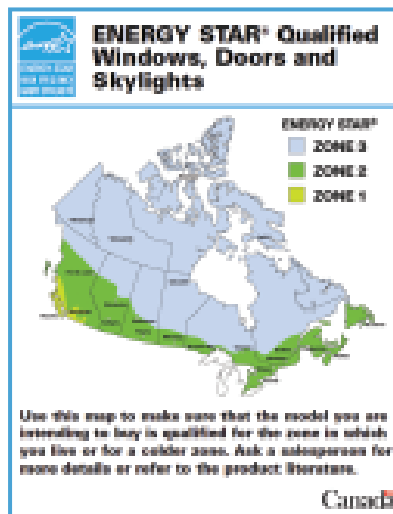



HERITAGE COLLECTION

Traditional designs meet modern day technology in our Heritage Collection of casement, awning and fixed windows. Our engineers have taken the classic contours of a hand crafted wood window and combined them with the performance and durability of vinyl. The Heritage Collection will bring that timeless beauty to your home and add value without sacrificing quality.

Our 3 1/4" fusion-welded frame and sash offer superior strength. Our standard hardware uses a Premium Hardware crank and a multi-point lever lock for ease of operation and security with eight different crank colour choices available.

Our standard unit is double-strength glass which comes with our warm edge S-Class super spacer with the option of triple pane glass with Argon, Krypton or a mix of Argon/Krypton gas.



COLOUR OPTIONS

Solid Colours

Interior Exterior



White White

Exterior Colour Option

Interior Exterior



White Black

Exterior Colours (Two Tone) uPVC CapStock

Interior Exterior



White Sandstone

Interior Exterior



White Dark Bronze

Traditional Design Modern Technology

Heritage Series: Casement, Awning, Fixed

Heritage
COLLECTION



HC-101 CASEMENT

Casement windows offer top to bottom unobstructed views, structural integrity and wide open ventilation. They are hinged on the side so the sash swings outward either left or right depending on your needs. These windows open up to 90 degrees so you can easily clean both sides of the glass from the inside plus you can also remove our easy-clean screen for simple cleaning.



HC-126 AWNING

Awning windows allow the window sash to swing out and upwards and are typically hinged at the top. Our Awning windows open up to 45 degrees from the bottom letting air circulate freely, while providing a unique protective shield to keep rain out and come with an easy-clean removable screen.



HC-176 CASEMENT

Casement Fixed windows do not open and are designed with a structural frame to accommodate larger openings. The classical contours of the frame are designed to match the size and appearance of our casement and awning windows for an attractive and uniform look and operational versatility for your home.



FIXED HC-151 SLIM-FIXED

This Slim-Fixed window does not open but comes with a low profile design and a narrow frame to create a distinctive look and also maximizes the glass viewing area. Slim-Fixed windows can be ordered in an unlimited range of architectural shapes and curves to make custom design creations possible and incorporates structural and thermal chambers for superior strength in large openings.



HERITAGE COLLECTION

The Heritage Collection of Hung and Sliding windows combine the classic look of a heritage window with today's technology and performance. The attention to detail continues with contoured sashes and frames recreating the hand crafted wood look.

Our 3 1/4" fusion-welded frame and sash offer superior strength plus a full aluminum reinforced interlocking sash to maximize security. We use a constant force stainless steel balance system to ensure smooth operation of the movable section(s). Our standard flush mounted low profile locks provide an unobstructed view with eight different Premium Hardware colour choices available.

Our standard unit is double-strength glass which comes with our warm edge S-Class super spacer with the option of triple pane glass with Argon, Krypton or a mix of Argon/Krypton gas.



COLOUR OPTIONS

Solid Colours

Interior	Exterior
White	White

Exterior Colours (Two Tone)
uPVC CapStock

Interior	Exterior
White	Sandstone

Traditional Design Modern Technology

Heritage Series: Hung, Sliders

Heritage
COLLECTION



HC-211 SINGLE HUNG

Hung windows are a traditional style of window found in many homes where the bottom sash slides up to open the window and the top sash is fixed. The sash also tilts in to permit easy exterior cleaning from the inside plus it comes with a removable easy to clean half screen.



HC-261 DOUBLE HUNG

Double Hung windows can open from the top or bottom with an upper and lower sash that slide vertically past each other in a single frame allowing more flexibility in ventilation. This is a window style commonly seen in many elegant homes. Both sashes also tilt in to permit easy exterior cleaning from the inside and the window comes with a removable easy to clean full screen.



HC-210 SINGLE SLIDER

Our Single Slider window has only one sash that slides horizontally within the frame with the other sash fixed. The normal slide is from left to right (viewed from the outside) but the opposite slide is available (must be specified when you order) and the sash tilts in for easy exterior cleaning from the inside. This window comes with a half screen that is on the opening end operation only and is removable for easy cleaning.



HC-260 DOUBLE SLIDER

Our Double Slider window has both sashes that slide horizontally within the frame and are perfect for a large window area where maximum ventilation is required without obstructing the view. Both sashes move and tilt in for easy exterior cleaning from the inside and come with a full screen that is removable for easy cleaning.



Heritage Plus

COLLECTION

Heritage Plus Collection has the added advantage of strategically located High Density Expanded Polystyrene Foam (EPS) inserted into the profile cavities of the window. This system enhances the overall performance of the Heritage Collection windows by adding stiffness and reducing noise transmission through the frame and it increases the overall Thermal Resistance of the windows. As a result, you get a window that is stronger, more resilient to any impact, quieter and more thermally efficient from both cold, heat or air transfer and it is environmentally safe.



HC-101 CASEMENT

COLOUR OPTIONS

Solid Colours

Interior Exterior



White White

Exterior Colour Option

Interior Exterior



White Black

Exterior Colours (Two Tone) uPVC CapStock

Interior Exterior



White Sandstone

Interior Exterior



White Dark Bronze

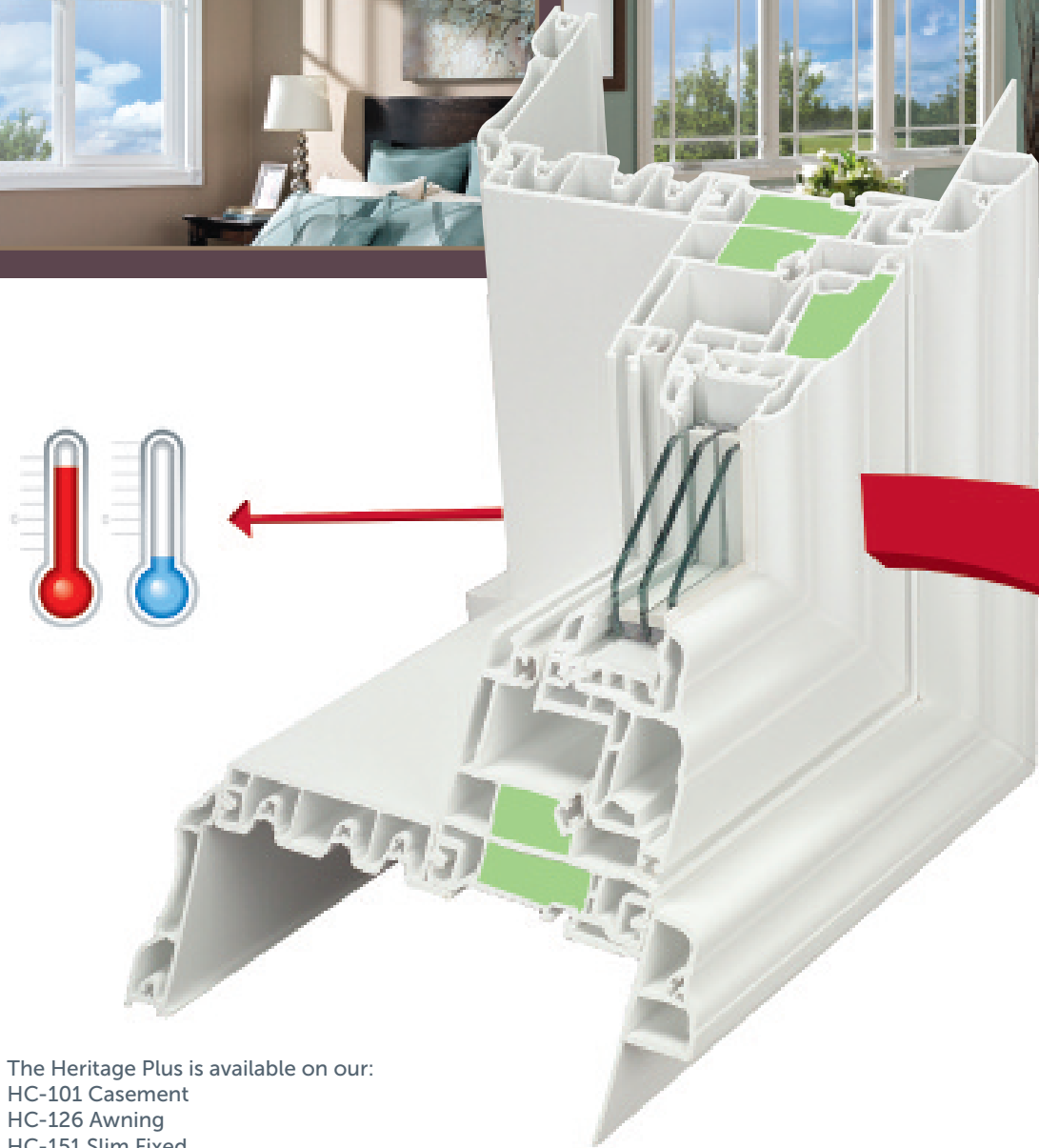

FEATURES

- Stronger window
- More resilient to impacts
- Quieter, reduces noise transmission
- More thermally efficient from cold, heat or air transfer
- Environmentally safe



The Heritage Plus is available on our:
HC-101 Casement
HC-126 Awning
HC-151 Slim Fixed
HC-176 Casement Fixed
HC-210 Single Slider Tilt
HC-211 Single Hung Tilt Pocket Sill
HC-260 Double Slider Tilt
HC-261 Double Hung Tilt Pocket Sill



HERITAGE MAXIMUM COLLECTION

The attention to detail distinguishes the Heritage Maximum Collection of casement, awning and fixed windows, creating beautiful vistas throughout your home. Unlike any other window, our traditional design combined with modern day technology has resulted in quality and performance second to none.

Our 4½" fusion-welded frame and sash offer superior strength. This is the slimmest profile in the industry today and has 40% less frame obstruction creating expansive views and increased daylight in any opening. Heritage Maximum windows come with Premium Hardware for effortless operation with eight different colour choices available plus a multi-point locking system to create a tight seal and provide greater security.

This collection comes with double-strength glass and our warm edge S-Class super spacer with the option of triple pane glass with Argon, Krypton or a mix of Argon/Krypton gas.



COLOUR OPTIONS

Solid

Interior	Exterior
White	White

Exterior Colours (Two Tone) uPVC CapStock

Interior	Exterior	Interior	Exterior	Interior	Exterior
White	Black	White	SandStone	White	Dark Bronze

First of Its Kind

Heritage Maximum Series:
Casement, Awning, Fixed

Heritage
Maximum
COLLECTION



HC-401 CASEMENT

Casement windows offer top to bottom unobstructed views, structural integrity and wide open ventilation. They are hinged on the side so the sash swings outward either left or right depending on your needs. These windows open up to 90 degrees so you can easily clean both sides of the glass from the inside plus you can also remove our easy-clean screen for simple cleaning.

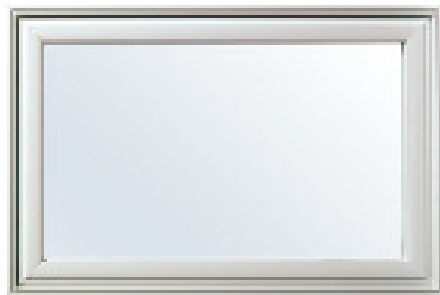

HC-426 AWNING

Awning windows allow the window sash to swing out and upwards and are typically hinged at the top. Our Awning windows open up to 45 degrees from the bottom letting air circulate freely, while providing a unique protective shield to keep rain out and come with an easy-clean removable screen.



HC-476 CASEMENT FIXED

The Casement Fixed windows do not open and are designed with a structural frame to accommodate larger openings. The classic contours of the frame are designed to match the size and appearance of our casement and awning windows for an attractive and uniform look and operational versatility for your home.



HC-451 SLIM-FIXED

This Slim-Fixed window does not open but comes with a low profile design and a narrow frame to create a distinctive look and maximizes the glass viewing area. Slim-Fixed windows can be ordered in an unlimited range of architectural shapes and curves to make custom design creations possible and incorporates structural and thermal chambers for superior strength in large openings.



CLASSIC COLLECTION

Window City's exclusive Classic Collection of casement, awning and fixed windows incorporates superior structural integrity along with quality and unmatched performance.

Our 3 1/4" fusion-welded frame and sash offer superior strength. Our standard hardware uses a Premium Hardware crank and a multi-point lever lock for ease of operation and security with eight different colour choices available.

Standard unit is double-strength glass which comes with our warm edge S-Class super spacer with the option of triple pane glass with Argon, Krypton or a mix of Argon/Krypton gas.



COLOUR OPTIONS

Solid Colours

Interior	Exterior
White	White

Exterior Colours (Two Tone) uPVC CapStock

Interior	Exterior	Interior	Exterior	Interior	Exterior
White	Sandalwood	White	Ivory	White	Black
White	SandStone	White	Dark Bronze		

Superior Structural Integrity

Classic Series: Casement, Awning, Fixed

Classic
COLLECTION



WC-100 CASEMENT

Casement windows offer top to bottom unobstructed views, structural integrity and wide open ventilation. They are hinged on the side so the sash swings outward either left or right depending on your needs. These windows open up to 90 degrees so you can easily clean both sides of the glass from the inside plus you can also remove our easy-clean screen for simple cleaning.



WC-125 AWNING

Awning windows allow the window sash to swing out and upwards and are typically hinged at the top. Our Awning windows open up to 45 degrees from the bottom letting air circulate freely, while providing a unique protective shield to keep rain out and come with an easy-clean removable screen.



WC-175 CASEMENT FIXED

Casement Fixed windows do not open and are designed with a structural frame to accommodate larger openings. The classic contours of the frame are designed to match the size and appearance of our casement and awning windows for an attractive and uniform look and operational versatility for your home.



WC-150 SLIM-FIXED

This Slim-Fixed window does not open but comes with a low profile design and a narrow frame to create a distinctive look and also maximizes the glass viewing area. Slim-Fixed windows can be ordered in an unlimited range of architectural shapes and curves to make custom design creations possible and incorporates structural and thermal chambers for superior strength in large openings.



CLASSIC COLLECTION

Window City's exclusive Classic Collection of hung and slider windows incorporates superior structural integrity along with quality and unmatched performance.

Our 3 1/4" fusion-welded frame and sash offer superior strength plus we use a multi-chambered design which insulates and prevents condensation. Our hardware comes with a heavy-duty cam action locking system for security and we use a triple weather-stripping sealing system located on the sash for total air and water tightness.

Standard unit is double-strength glass which comes with our warm edge S-Class super spacer with Argon, Krypton or a mix of Argon/Krypton gas.



COLOUR OPTIONS

Solid Colours

Interior Exterior



White White

Exterior Colours (Two Tone) uPVC CapStock

Interior Exterior



White Sandstone

Interior Exterior



White Ivory

Interior Exterior



White Sandalwood

Quality and Unmatched Performance

Classic Series: Hung, Slider

Classic
COLLECTION



WC-201 SINGLE HUNG

Hung windows are a traditional style of window found in many homes where the bottom sash slides up to open the window and the top sash is fixed. The sash also tilts in to permit easy exterior cleaning from the inside plus it comes with a removable easy to clean half screen.



WC-251 DOUBLE HUNG

Double Hung windows can open from the top or bottom with an upper and lower sash that slide vertically past each other in a single frame allowing more flexibility in ventilation. This is a window style commonly seen in many elegant homes. Both sashes also tilt in to permit easy exterior cleaning from the inside and the window comes with a removable easy to clean full screen.



WC-200 SINGLE SLIDER

Our Single Slider window has only one sash that slides horizontally within the frame with the other sash fixed. The normal slide is from left to right (viewed from the outside) but the opposite slide is available (must be specified when you order) and the sash tilts in for easy exterior cleaning from the inside. This window comes with a half screen that is on the opening end operation only and is removable for easy cleaning.



WC-250 DOUBLE SLIDER

Our Double Slider window has both sashes that slide horizontally within the frame and are perfect for a large window area where maximum ventilation is required without obstructing the view. Both sashes move and tilt in for easy exterior cleaning from the inside and come with a full screen that is removable for easy cleaning.



CLASSIC COLLECTION

Window City's exclusive Classic Collection of single or double slider windows incorporates superior structural integrity along with quality and unmatched performance.

Our frame and sash are fusion-welded offering superior strength plus we use a multi-chambered design which insulates and prevents condensation. We have fully interlocking sashes to maximize the security and minimize air infiltration and they glide on a dual roller system for smooth opening and closing.

Standard unit is double-strength glass which comes with our warm edge S-Class super spacer with Argon, Krypton or a mix of Argon/Krypton gas.



COLOUR OPTIONS

Solid Colours

Interior Exterior



White White

Exterior Colours (Two Tone) uPVC CapStock

Interior Exterior



White Sandstone

Interior Exterior



White Ivory

Interior Exterior



White Sandalwood

Contemporary Operating Design

Classic Series: Single and Double Slider Lift Out

Classic
COLLECTION



WC-300 SINGLE SLIDER

Our WC-300 Single Slider window has a 4½" fusion welded frame and only one sash that slides horizontally within the frame with the other sash fixed. The normal slide is from left to right (viewed from the outside) but the opposite slide is available (must be specified when you order) and the sash lifts out for easy exterior cleaning from the inside. This window comes with a half screen that is on the opening end operation only and is removable for easy cleaning. **Available in white and sandalwood exterior colours only.**



WC-325 SINGLE SLIDER

Our WC-325 Single Slider window has our standard 3¼" fusion welded frame and only one sash that slides horizontally within the frame with the other sash fixed. The normal slide is from left to right (viewed from the outside) but the opposite slide is available (must be specified when you order). The sash tilts in for easy exterior cleaning from the inside and also lifts out. This window comes with a half screen that is on the opening end operation only and is removable for easy cleaning.



WC-350 DOUBLE SLIDER

Our Double Slider window has our standard 3¼" fusion welded frame and both sashes slide horizontally within the frame. This is perfect for a large window area where maximum ventilation is required without obstructing the view. Both sashes move and lift out for easy cleaning of both sides and come with a full screen that is also removable. **Not available in sandstone.**



CLASSIC COLLECTION

Window City's exclusive Classic Collection of casement, awning and fixed windows incorporates superior structural integrity along with quality and unmatched performance. The windows come with a tapered brickmould built into the frame and are ready to finish in any masonry opening.

Our 4½" fusion-welded frame and sash offer superior strength. Our standard hardware uses a Premium Hardware crank and a multi-point lever lock for ease of operation and security with eight different colour choices available.

Standard unit is double-strength glass which comes with our warm edge S-Class super spacer with the option of triple pane glass with Argon, Krypton or a mix of Argon/Krypton gas.



COLOUR OPTIONS

Solid Colours

Interior Exterior



White White

Exterior Colours (Two Tone) uPVC CapStock

Interior Exterior



White Sandalwood

Superior Strength Plus Added Value

Classic Series: Casement, Awning, Fixed

Classic
COLLECTION



WC-400 CASEMENT

Casement windows offer top to bottom unobstructed views, structural integrity and wide open ventilation. They are hinged on the side so the sash swings outward either left or right depending on your needs. These windows open up to 90 degrees so you can easily clean both sides of the glass from the inside plus you can also remove our easy-clean screen for simple cleaning.

WC-425 AWNING

Awning windows allow the window sash to swing out and upwards and are typically hinged at the top. Our Awning windows open up to 45 degrees from the bottom letting air circulate freely, while providing a unique protective shield to keep rain out and come with an easy-clean removable screen.

WC-475 CASEMENT FIXED

Casement Fixed windows do not open and are designed with a structural frame to accommodate larger openings. The classic contours of the frame are designed to match the size and appearance of our casement and awning windows for an attractive and uniform look and operational versatility for your home.

WC-450 SLIM-FIXED

This Slim-Fixed window does not open but comes with a low profile design and a narrow frame to create a distinctive look and also maximizes the glass viewing area. Slim-Fixed windows can be ordered in an unlimited range of architectural shapes and curves to make custom design creations possible and incorporates structural and thermal chambers for superior strength in large openings.

Bay Windows



Bay windows are much desired by homeowners because of the way they project outwards to extend a home, creating more living space. From the interior they can become a graceful, sunlit place in the home and provide a panoramic view. From the exterior, they offer a welcoming, decorative and architectural touch. Bay windows are versatile and they can be the primary front living room window or can also be used as a side or rear window or anywhere there is sufficient exterior projection space in the home. The beauty of Bay windows can be greatly enhanced by our grille options and our accessory items. The durability and energy efficient features found in all Window City windows apply to our Bay windows. **All Bay windows must be custom-built to specific applications.**

Bow Windows



Bow windows are welcomed by homeowners and frequently called for by architects because of their grand, sweeping curves that can turn a standard window opening into an appealing architectural enhancement. Bow windows are projection windows that have the benefit of adding space to a home. They do not project outward as far as Bay windows and have more glass panels and softer, more rounded angles. Interior designers love Bow windows because their outward extension invites the creation of a very picturesque setting in the home, one that allows for a magnificent exterior view. For fresh air circulation and temperature comfort, any or all sections of our Bow windows can be made operable by adding any of our operating system options. They have all the strength and durability features built into every Window City window. **Every Bow window is somewhat unique and therefore must be custom-built to the specifications of the space where it is to be installed.**

Architectural Shapes

Sophisticated curves, arches, circles and other geometric shapes, plus a willingness to accommodate the creative demands of the most demanding home designers keeps architects coming back consistently to Window City for windows that are more than mere windows. Many of North America's most distinctive homes feature windows fashioned by us. Yes, we have standard shapes but we are highly regarded for our ability to create customized shapes and window configurations. We have an unlimited range of architectural shapes and curves which open up innovative design possibilities.

The added advantage of our unlimited grille options can turn any window architectural concept into reality. Our Architectural Series windows can be used in new construction or as replacement windows. Despite the attention to design, our Architectural Series windows do not neglect the durability and energy efficiency features built into all Window City windows.

Windows City uses patented PVC mullions with steel reinforcement which add strength, performance and security. This allows us to produce much larger window units with a mix of both fixed and operating windows.

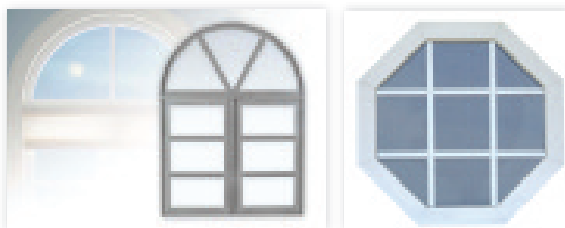
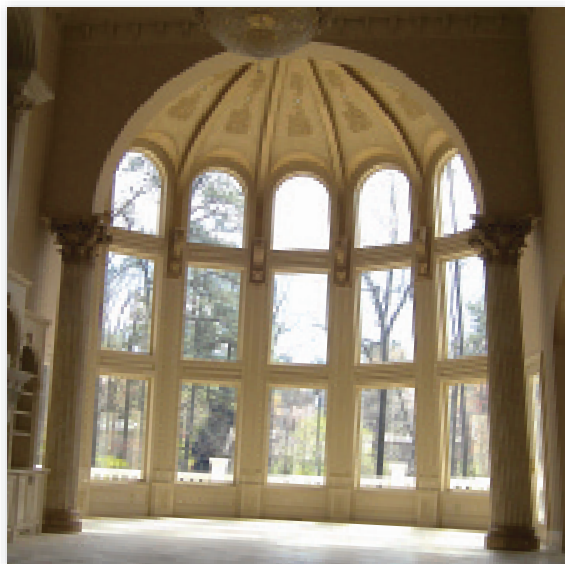

Trim Options

All Window City products can be customized to meet your exact application requirements with our extensive accessory options that are factory applied and fully integrated into your windows. The possibilities are endless with either standard or custom interior and exterior accessories. We at Window City manufacture our own accessories ensuring a perfect fit and finish for all of our products. Our accessories are fully functional for your application and add detail to your windows.

INTERIOR



Interior PVC Trim packages. Custom made for your windows and doors to create the ultimate precision finishes.

EXTERIOR



Exterior PVC Brickmould trim. Details replicate the traditional exterior window and door components. Reminiscent of hand crafted windows and doors.

WINDOW CROSS SECTION WITH TRIM ACCESSORIES

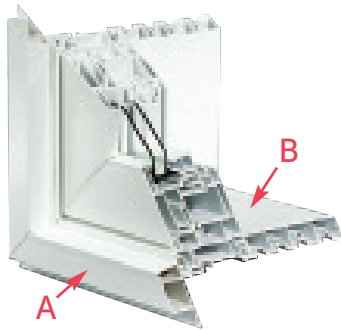

WC-100 Casement

- A - 1" Brickmould with Fin
- B - 3 3/8" PVC Jamb

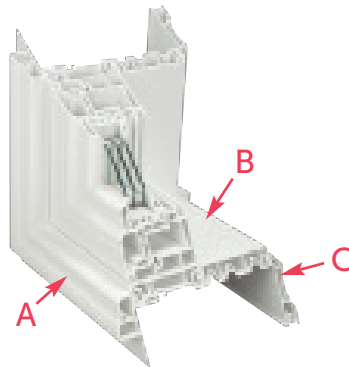

HC-101 Casement

- A - 1 1/2" Brickmould with Fin
- B - 3 3/8" PVC Jamb
- C - 2 3/4" PVC Casing

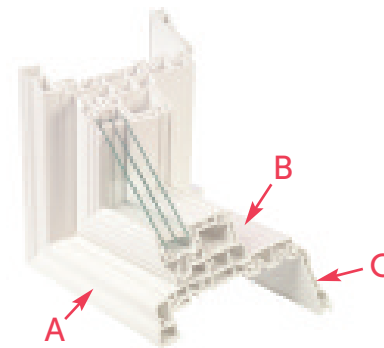

HC-401 Casement

- A - 1 1/2" Brickmould
- B - 2 1/2" PVC Jamb
- C - 2 3/4" PVC Casing

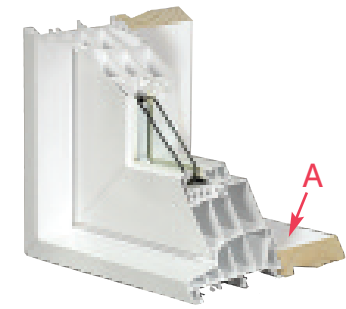

WC-475 Fixed Casement

- A - 3 3/16" Primed Paint Wood Jamb

Grille Options

WINDOW CITY OFFERS A FULL SELECTION OF GRILLES AND DIVIDED LITE OPTIONS.

Grilles and divided light options can add a whole new dimension to your home's appearance. Window City can create that unique architectural element by customizing either your internal or external grille selections. Custom grilles can be conveniently located between the glass for easy maintenance or for a more traditional look, exterior Simulated Divided Lite options are available.



INTERIOR GRILLES

Totally maintenance-free, these grilles are inside the insulated glass. The available profiles, colours and styles can give you a perfect way to add an extra level of decorative detail and styling.



SIMULATED DIVIDED LITES (SDL)

SDL grilles will provide the traditional look of hand crafted windows while maintaining a single sealed glass unit. You can choose from various sizes, patterns and colour options, all designed to enhance the unique style of your home.



DECORATIVE and V-GROOVE

Our decorative units made up of solid metals, beveled, grooved and tinted glass provide the ultimate architectural look. Coming options include brass, zinc or patina, encased between two panes of glass.



GRILLE OPTIONS FOR WINDOWS AND DOORS



Colonial



Georgian
5/8"



Georgian
1"



Pencil



V-Groove



SDL 3/4"



SDL 1"



Beveled Glass

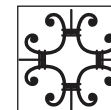

Ferro - Z1



Infinito - Z2

Ultra Patio Door

SLIDING COLLECTION

The Ultra Patio Door Sliding Collection from Window City allows you to invite the outdoors into your home without sacrificing comfort or security. Ultra Sliding doors are not just for patios these days, they are at home in any room. Brighten your home with endless natural light and the beauty of the outdoors. The classic sight lines and ease of operation combined with several colour options allows this door to fit anywhere in your home. If you desire to add a patio door, Window City's Ultra Patio Door is available with all the necessary interior and exterior trim options to finish the job.

The Window City Ultra Patio Door Sliding Collection is available in standard 5', 6' and 8' two-panel models as well as 10', 12' and 16' four-panel units. The insulated kick plate option adds a distinct architectural flavour to your home. The Ultra Patio Door Sliding Collection can be combined with several custom sidelites, transoms, grille and glass options. Custom sizes are available through our automated manufacturing facility.



The patio door as shown comes standard with PVC mullion including steel reinforcement (sidelites and transoms included) for additional strength and performance.



COLOUR OPTIONS

Solid Colours

Interior	Exterior
	
White	White

Exterior colour (two-tone) uPVC Capstock

Interior	Exterior
	
White	Sandalwood

Interior	Exterior
	
White	Ivory

Interior	Exterior
	
White	Black

Interior	Exterior
	
White	SandStone

Interior	Exterior
	
White	Dark Bronze

TWIN-POINT HARDWARE OPTIONS

All hardware available with (optional) key locks

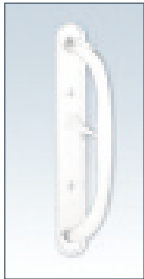

Standard White



Bright Brass

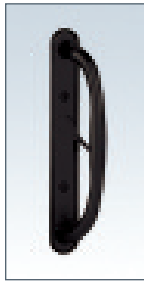

Flat Black

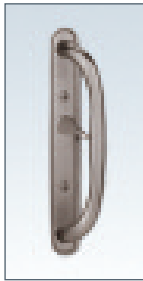

Satin Nickel



SOLAR SOLUTION OPTIONS

Our glazing options provide you with maximum energy efficiency in all 4 seasons. Regardless of the climate you live in or the style of door you choose, our Solar Solutions glass options can be selected to customize each room and provide the safety and performance you require.

Tempered glass is standard on the Ultra Patio Door Sliding Collection from Window City. All Ultra Patio doors come standard with tempered glass in the double and triple glazed options.

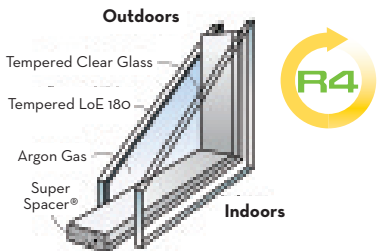

R4 Tempered LoE 180, Argon with Super Spacer®

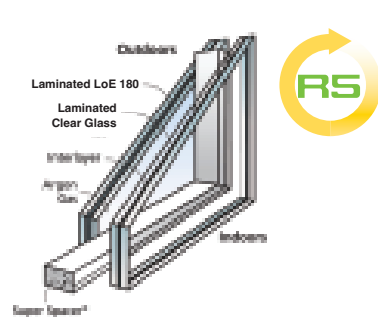

R5 (Custom Patio Door)
Laminated, LoE 180, Argon with Super Spacer®

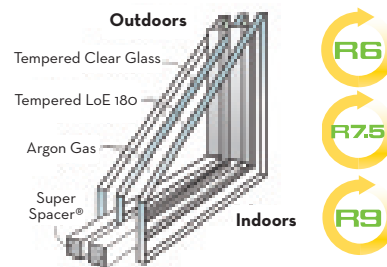

R6 Tempered Triple Pane, LoE 180, Argon with Super Spacer®
R7.5 Tempered Triple Pane, LoE 180, 50% Argon / 50% Krypton with Super Spacer®
R9 Tempered Triple Pane, LoE 180, Krypton with Super Spacer®





Ultra Patio Door

SWING COLLECTION

Our Ultra Patio Door Swing Collection incorporates superior structural integrity along with quality and unmatched performance with our exclusive all uPVC and aluminum reinforced frame system. A truly unique door system that offers full customization from size, hardware, colour, accessories and an extensive glass selection.

Ultra Patio Door Swing Collection frames and sashes are welded on all four corners which guarantee an airtight seal and a perfectly square doorframe every time and can be combined with sidelites and transoms to create an entrance truly customized for you.

The structural reinforcement is strategically positioned to strengthen key areas of the frame that support the adjustable hinges and the standard multipoint hardware. The system is designed with a patented fully weeped sill with offset covered drainage channel is available with clear aluminum anodized or dark bronze finish.

Window City uses a patented PVC mullion including steel reinforcement (sidelites and transoms included) for additional strength and performance.

COLOUR OPTIONS

Solid

Interior Exterior



White White

Exterior Colour Option

Interior Exterior



White Black

Exterior colour (two-tone) uPVC Capstock

Interior Exterior



White Sandalwood

Interior Exterior



White Dark Bronze

Interior Exterior



White SandStone



AUTOMATIC MULTIPOINT LOCKING

Our Lever handle set provides beauty and security with our automatic locking system.

Standard Feature and Benefits:

- European technology in a North American Lock
- By simply closing the door the upper and lower 3/4" (290mm) latches will instantly engage
- By turning the key from the outside or the knob from the inside, it will engage the 1" central deadbolt and lock the top and bottom latches to become a 3 deadbolt locking system



LEVER SET STYLE & SERIES

Our 9" long hardware is available in the Capri, Torino, Venice or Allegro Series lever set style and are offered in four elegant finish options. The Venice series is standard while the other series may require longer delivery time. Your doors will function and perform beautifully for years to come with our automatic locking system.

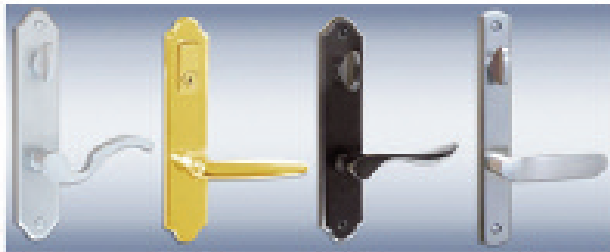

Capri Series Torino Series Venice Series Allegro Series (Standard)

Our 12" long hardware is available in three finishes: Black, Satin Nickel and Antique Brass

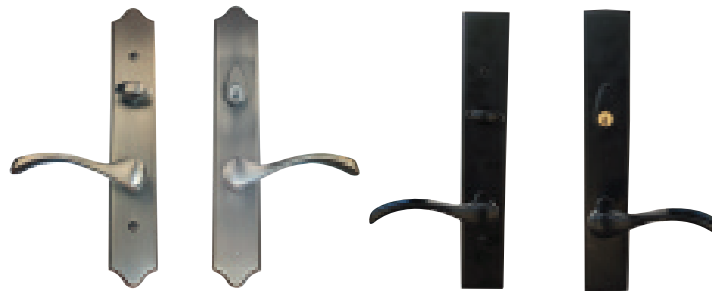

Interior Exterior

Expression
Satin Nickel Finish

Interior Exterior

True Elegance
Black Finish

Berkeley

Salem

Swing Door Grip Set Handles 18"



STANDARD ADJUSTABLE HINGES (2D)

2D hinge design incorporates a snap feature allowing the jamb leaf to easily snap into the panel leaf, a great advantage in the door hanging process. The system comes in a vertical adjustment as well as a horizontal adjustment hinge. Available in multiple finish options.

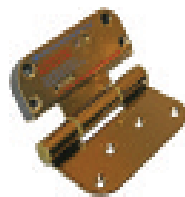

HARDWARE COLOUR OPTIONS

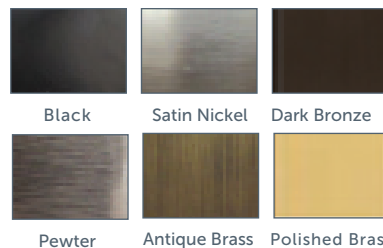

Black Satin Nickel Dark Bronze

Pewter Antique Brass Polished Brass

	Black	Satin Nickel	Dark Bronze	Pewter	Antique Brass	Polished Brass
Grip Set Handles 18"	●	●	●	●		
Trim Sets 12"	●	●			●	
Trim Sets 9"	●		●		●	●

Lifetime

Entry Door

COLLECTION

Our Lifetime Entry Door Collection incorporates superior structural integrity along with quality and unmatched performance with our exclusive all uPVC, aluminum reinforced frame system. A truly unique door system that offers full customization from size, configuration, hardware, colour, and an extensive glass selection, unmatched in the industry today.

The frames are welded on all four corners which guarantees an airtight seal and a perfectly square door frame every time. The structural reinforcement is strategically positioned to strengthen key areas of the frame that support the adjustable hinges and the optional multipoint hardware. Combination units are available with an optional structural aluminum reinforcement for added strength and stability. All of the interior and exterior trim accessories are available and match perfectly with our window products.

The Lifetime Entry Door Collection is a fully customized entry system accommodating several door options, including Steel, Fiberglass or Wood door panels. Sidelites, transoms and multiple door configurations will no longer require extra production times as our system will handle any custom requests inhouse.

Any Lifetime Entry Door Collection combinations come standard with patented PVC mullions including steel reinforcement which add strength, performance and security.

COLOUR OPTIONS

Solid

Interior	Exterior
	
White	White

Exterior Colour Option

Interior	Exterior
	
White	Black

Exterior colour (two-tone) uPVC Capstock

Interior	Exterior	Interior	Exterior	Interior	Exterior
					
White	Sandalwood	White	Dark Bronze	White	SandStone

Classic Entry Door

COLLECTION

Window City's Classic Entry Door Collection has been built with care using the latest innovations in today's door construction technology.

This entry door collection is available with a variety of frame systems which satisfy customer requirements. Like traditional doors they come with solid wood frames (finger joined pine wood, white oak and mahogany as well as solid composite with a stainable oak woodgrain). For customers who prefer a low maintenance frame system, Window City offers the solid finger joined wood frame with an exterior vinyl wrap in various finishes (white, sandalwood, sandstone, dark bronze and black) with the inside in finger joined pine (unfinished). Also, we offer the same solid wood frame with an interior white vinyl wrap with the exterior in your choice of white, sandalwood, sandstone, dark bronze or black.

The Classic Entry Door Collection is a fully customized entry system where you can choose from several panel options including Steel, Fiberglass (Smooth and Textured) or Engineered Wood. There are many styles, options and accessories to choose from including sidelites, transoms, decorative glass, hardware, paint or stain to create the best looking entry door to suit your beautiful home.

COLOUR OPTIONS

Solid Wood Frame



Composite Frame



Exterior Vinyl Wrap



Full Vinyl Wrap

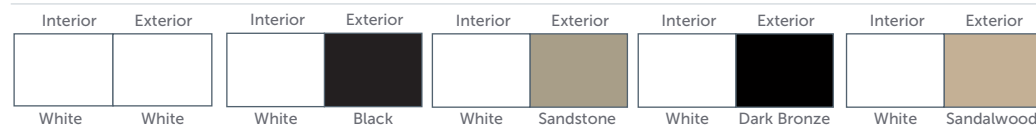



ULTIMATE STEEL PANEL

Elegance Entry Door SERIES

The Elegance steel doors feature the strength of steel with classic door configurations. High-definition decorative panel profiles create outstanding details that replicate the appearance of a high end wood door that add style and distinction. The lock area is reinforced with a lock block to provide a solid mounting surface and high-performance composite material is utilized on all bottom rails to resist rotting. The Elegance Steel door has a smooth, pre-finished white surface that requires no additional finishing or you can choose to have a custom colour painted to compliment your home's exterior. There are several designer glass selections available to add beauty and distinction to your entry doors.



6'8" DOORS



F (flush)* 2PC 2PP 2PH 2PS 3PA 4PB C2P 6P* 8P 9P SLF* SL2* SL3 SL1C

* Panels are available in 8'0

Citadel Entry Door

SERIES



SMOOTH FIBERGLASS PANEL



For the look and feel of traditional wood doors with minimal maintenance our Citadel Entry Door Series offers several fiberglass panel and sidelite options. Choose from a smooth surface ready for painting or several Oak and Mahogany grains that can be stained to provide the look and feel of real wood. Fiberglass panels are more durable and insulate better than steel and will withstand a wide range of temperatures while still maintaining their fit and finish for years to come. There are several designer glass selections available to add beauty and distinction to your entry doors. Our multipoint hardware will increase the performance and security of your door and we provide multiple finish options to complement your entry system.

6'8" DOORS

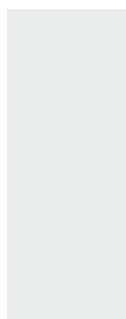

F (flush)*



2PS*



2PP*



3PA



4PB



4P



6PB



6P*



6PC



8P*



SLF*



SL2*

* Panels are available in 8'0



TEXTURED FIBERGLASS PANEL

Citadel Entry Door SERIES

For the look and feel of traditional wood doors with minimal maintenance, our Citadel Textured doors offer a great combination of Oak or Mahogany grain, the real wood door appearance but with the long-lasting performance of our superior fiberglass.



6'8" DOORS



F (Flush)* 1PA 2PS 3PA 4PB 4P 6PB 6P* 6P Mahogany* 2 PH Hollister Mahogany* 6PC 8P* SL2 Oak* SL2 Mahogany* SLF Mahogany

* Panels are available in 8'0

Castle Gate Entry Door

SERIES



Available in three sizes:

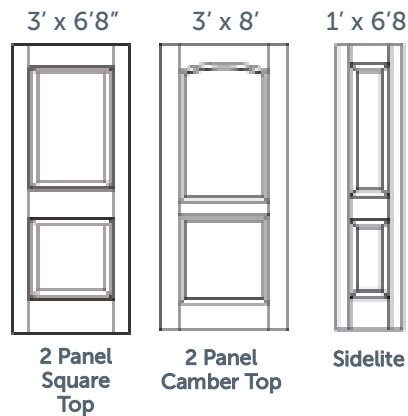

ENGINEERED WOOD PANEL

Nothing beats the richness of wood its splendor and natural beauty bring elegance and warmth to any home. CNC machining along with mortise and tenon construction ensure a quality fit and finish for your Castle Gate Entry Door Series. Door panels are available in Mahogany and Oak. Our multipoint hardware will increase the performance and security of your door and we provide multiple finish options to complement your entry system.

1 3/4" ENGINEERED STILE & RAIL WITH **3 PLY** PANELS AVAILABLE IN MAHOGANY AND OAK.



STANDARD FEATURES VERTICAL CROSS SECTION - WOOD PANEL

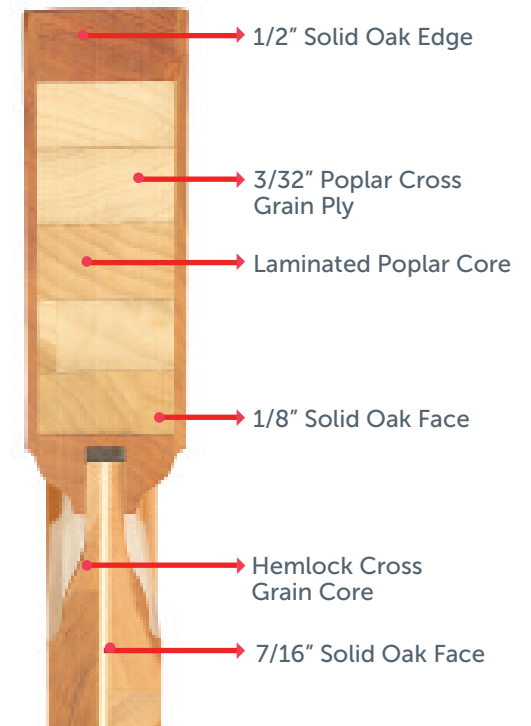

BARRINGTON

citadel premium series

Our Barrington Series offers the essence of luxury using timeless designs which complement almost any décor and offer long-lasting performance.

zinc caming



6'8" DOORS



2 Panel 3/4" Oval Lite Oak*



2 Panel 3/4" Oval Lite Mahogany*



2 Panel 3/4" Rectangle Lite*

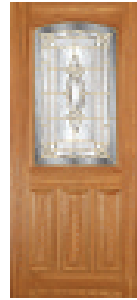

3 Panel 1/2" Camber Top*



1 Panel 3/4" Side Lite Oak*



Mahogany*



Side Lite Full*

* Panels are available in 8'0

CRAFTSMAN

citadel premium series

Window City's Craftsman styled doors bring the beauty of hand-crafted premium rift-cut oak or 'old growth' mahogany with the durability and ease of our low maintenance premium fiberglass.

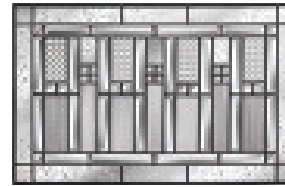

BC-4 Patina

6'8" DOORS



3 Panel Craftsman Oak BC-4

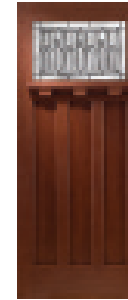

3 Panel Mahogany Oak BC-4



1 Panel Craftsman Oak BC-4



1 Panel Craftsman Mahogany BC-4

SIERRA & FLAGSTAFF

citadel premium series

Our Sierra series is designed with a rustic flair. The series incorporates gentle arches and beautiful 'old-growth' mahogany texture. Our Flagstaff Series features ribbon-striped mahogany texture and soft planking lines to create a more contemporary look that finishes easily, both use our low maintenance premium fiberglass.

6'8" DOORS



2 Panel Camber Top Plank*



2 Panel Camber Top*

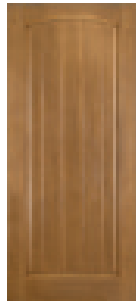

1 Panel Camber Top Plank*



Flagstaff Plank*

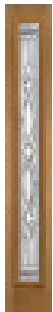

Zinc Full Sidelite*

* Panels are available in 8'0

AVANT GUARD

citadel premium series

Window City's AvantGuard series is the ideal fusion of wood and fiberglass. Some would call a beautiful wood door with little or no maintenance a dream. We call it Avant Guard and unlike any other door it perfectly blends beauty and durability into one patented package by combining the aesthetics of wood with the durability of fiberglass.

6'8" DOORS

SPANISH CEDAR



Flagstaff Plank*



Sierra 2 Panel Arch Top Plank*



Full Lite Sidelite*

6'8" DOORS & SIDELITE BLACK WALNUT



Flagstaff Plank*



Sierra 2 Panel Arch Top Plank*



Full Lite Sidelite*

* Panels are available in 8'0



DECORATIVE GLASS COLLECTION

Let Window City help you create a front entrance that will be the focal point of your home and a true reflection of your taste and style. No matter the size or style of your home, finding a glass style that complements what you have is important. Our decorative glass collection uses solid metals, textured and beveled glass and we brought it all together to create true works of art. We have a simple guide to allow you to decide on what level of "Privacy" is best for you (from clear to obscure) when choosing your glass style. You can also choose from hand soldered metals in three finishes from Brass, Patina (black satin finish) and Zinc (brushed chrome finish).

CAMING OPTIONS

BRASS CAMING



Subtle gloss finish that defines luxury and style.

PATINA CAMING



Black satin finish offers a rustic or antique look to your home.

ZINC CAMING

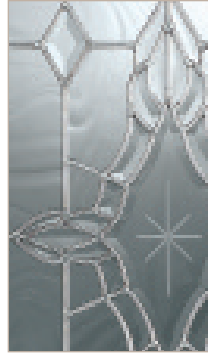

Brushed chrome appearance brings a contemporary look to your entrance.

collection



CLEAR GLASS



BEAUCHAMP

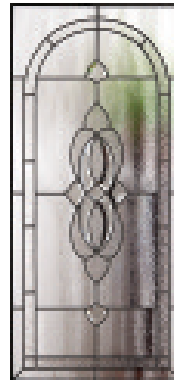

BLACKWATER

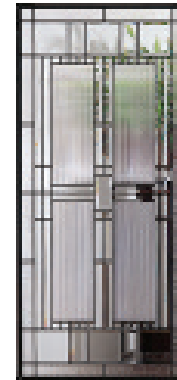

CHAMPLAIN

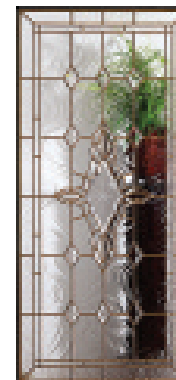

CUMBERLAND

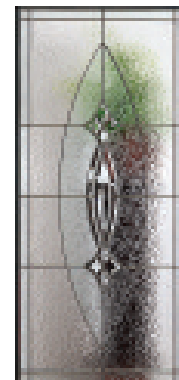

HUMBER



MATTAWA

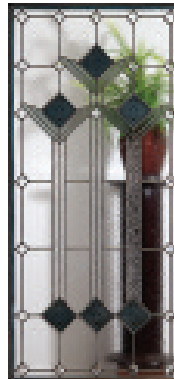

MUSKOKA

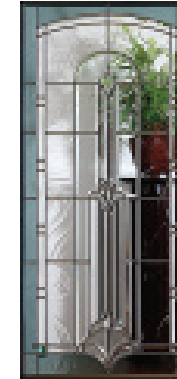

SAINT CLAIR



ST. LAWRENCE

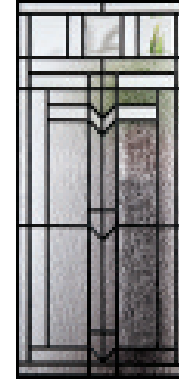

SHERBROOKE



SIMCOE



STONEY CREEK

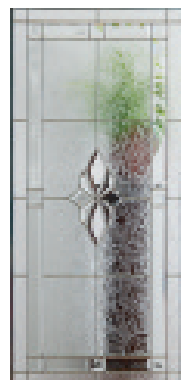

WELLAND



BARCELONA



FLORENCE



PALERMO



VALENZIA



* Please check for availability.

DECORATIVE GLASS COLLECTION

BEAUCHAMP



302-764 302-2264

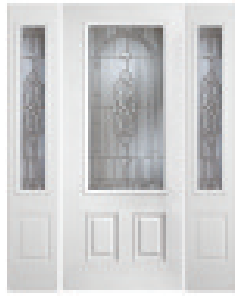

302-848 302-2248

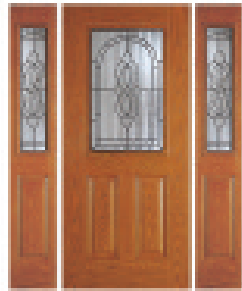

301-836 301-2236



301-2236R



301-1842

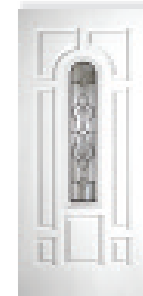

301-842R



301-2210

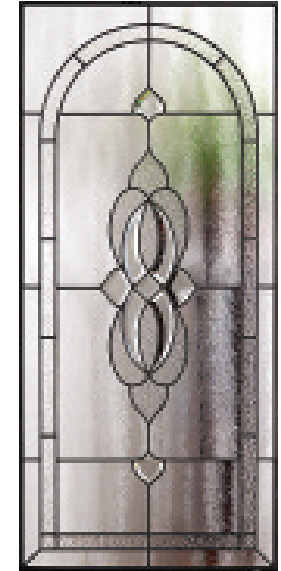

CAMING OPTIONS

Beauchamp	0836	2236	0848	2248	0764	1842	2264	2236R	842R	2210
Zinc	■	■	■	■	■	■	■	■	■	■
Patina	■	■	■	■	■	■	■	■	■	■

GLASS PRIVACY RATING

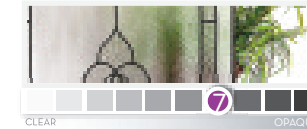

BLACKWATER

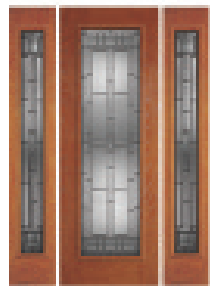

311-880 311-2280

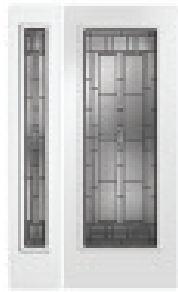

311-764 311-2264



311-848 311-2248

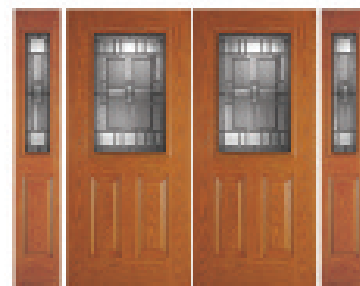

311-836 311-2236

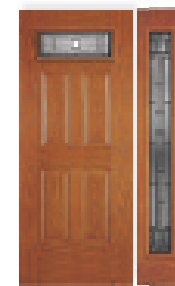

311-2210 311-764



311-2216



CAMING OPTIONS

Blackwater	0836	2236	0816	2216	0848	2248	0764	2264	2210	2280	0880
Patina	■	■	■	■	■	■	■	■	■	■	■

GLASS PRIVACY RATING

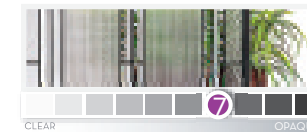

CHAMPLAIN



321-2264

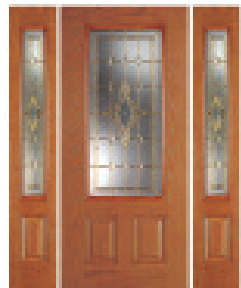

320-848 320-2248



322-836 322-2236



321-764 321-1842



322-2210R

CAMING OPTIONS

Champlain	0836	2236	0848	2248	0764	1842	2264	2210R
Brass	■	■	■	■		■		■
Zinc	■	■	■	■	■	■	■	■
Patina	■	■	■	■	■	■	■	■

GLASS PRIVACY RATING

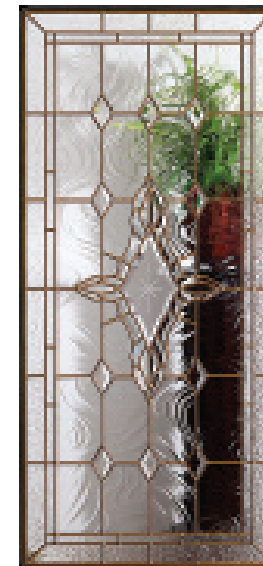
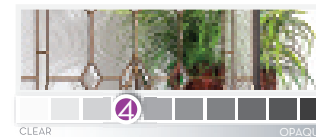

CUMBERLAND

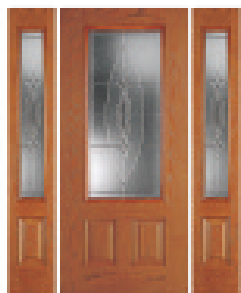

332-848 332-2248

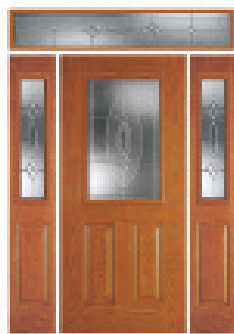

332-836 332-2236
with matching Transom



332-2057



332-764 332-1842

CAMING OPTIONS

Cumberland	0836	2236	0848	2248	0764	2057	1842
Zinc	■	■	■	■	■	■	■

GLASS PRIVACY RATING

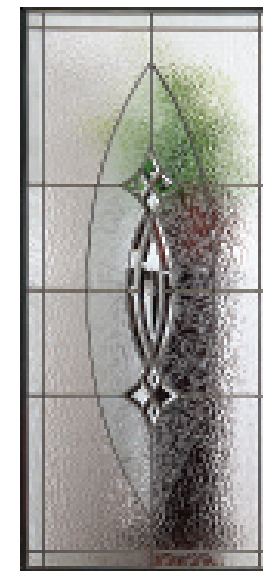
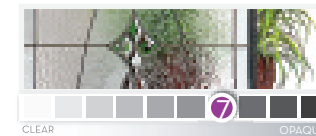

DECORATIVE GLASS COLLECTION

HUMBER



342-848/342-2248



340-836 340-2236



342-764 342-1842
with matching transom

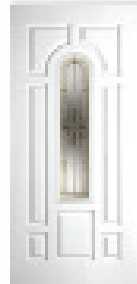

340-842R



341-2210R



342-718



CAMING OPTIONS

Humber	0836	2236	0848	2248	0764	1842	718	842R	2210R
Brass	■	■	■	■	■	■	■	■	■
Zinc	■	■	■	■	■	■	■	■	■
Patina	■	■	■	■	■	■	■	■	■

GLASS PRIVACY RATING



MATTAWA



352-764 352-2264
with matching Transom



352-848 352-2248



352-2236



352-1842

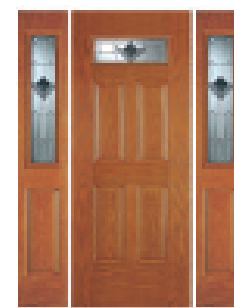

352-836 352-2210



CAMING OPTIONS

Mattawa	0836	2236	0848	2248	0764	1842	2264	2210
Zinc	■	■	■	■	■	■	■	■

GLASS PRIVACY RATING



MUSKOKA



CAMING OPTIONS

Muskoka	0836	2236	0848	2248	0764	1842	2236C	2264	2248C	2210C
Zinc	■	■	■	■	■	■	■	■	■	■
Patina	■	■	■	■	■	■	■	■	■	■

GLASS PRIVACY RATING

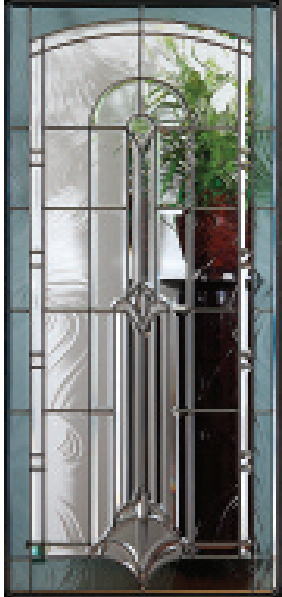

SAINT CLAIR



CAMING OPTIONS

Saint Clair	0836	0816	2216	2236	0848	2248	2248C	0764	2264	2210	2210C	2236C
Patina	■	■	■	■	■	■	■	■	■	■	■	■

GLASS PRIVACY RATING

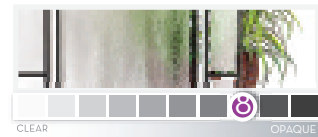

DECORATIVE GLASS COLLECTION

ST. LAWRENCE



381-764 381-2264

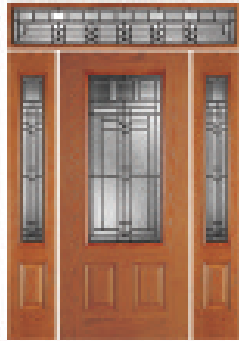

381-848 381-2248
with matching Transom



381-836 381-2236

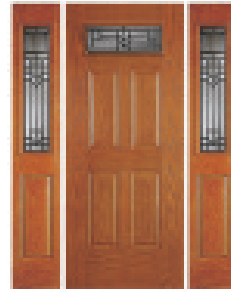

381-836 381-2210



381-2216



CAMING OPTIONS

St. Lawrence	0836	0816	2216	2236	0848	2248	0764	2264	2210
Patina	■	■	■	■	■	■	■	■	■

GLASS PRIVACY RATING



SHERBROOKE



391-2264

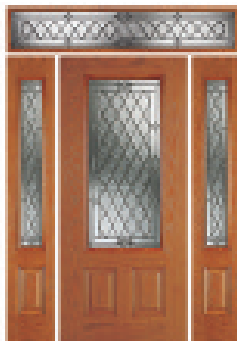

381-848 391-2248
with Matching Transom

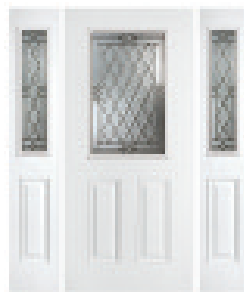

391-836 391-2236



391-764 391-1842



391-2210C

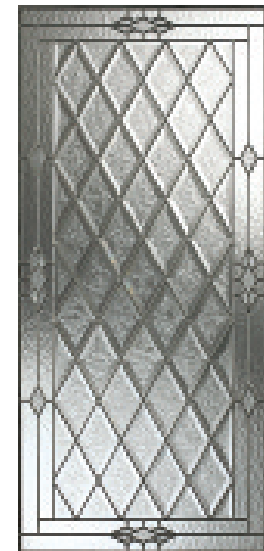

CAMING OPTIONS

Sherbrooke	0836	2236	0848	2248	0764	1842	2264	2210c
Patina	■	■	■	■	■	■	■	■

GLASS PRIVACY RATING



SIMCOE



400-2264



400-836 400-2236



402-764 402-2210R

CAMING OPTIONS

Simcoe	0836	2236	0764	2264	2210R
Brass	■	■	■	■	■
Zinc	■	■	■	■	■

GLASS PRIVACY RATING

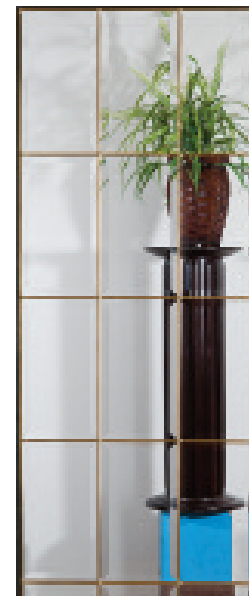
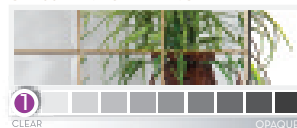

STONEY CREEK



Zinc 410-2236R

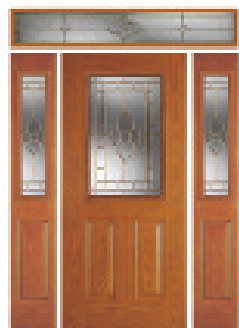

410-836 410-2236
with matching transom

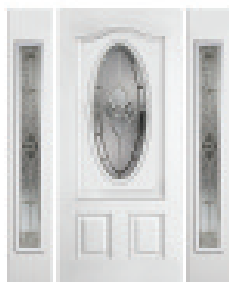

412-764 412-1842



412-848 412-2248

CAMING OPTIONS

Stoney Creek	0836	2236	0848	2248	0764	1842	2236R
Brass	■	■	■	■	■	■	■
Zinc	■	■	■	■	■	■	■

GLASS PRIVACY RATING

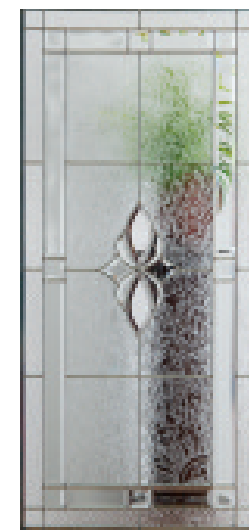

DECORATIVE GLASS COLLECTION

WELLAND

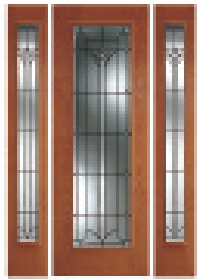

421-880 421-2280



421-764 421-2264



421-848 421-2248



421-836 421-2236

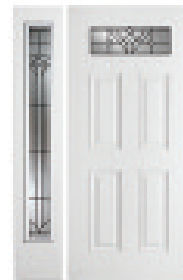

421-764 421-2210



421-2216



CAMING OPTIONS

Welland	0836	0816	2216	2236	0848	2248	0764	880	2264	2280	2210
Patina	■	■	■	■	■	■	■	■	■	■	■

GLASS PRIVACY RATING

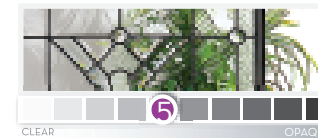

BARCELONA WROUGHT IRON

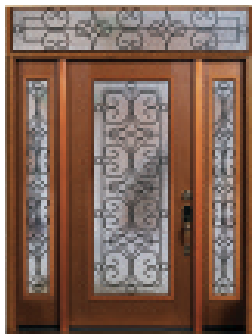

500-764 500-2264
with matching Transom



500-848 500-2248



500-836 500-2236

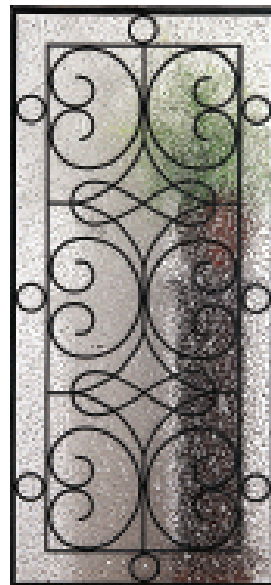

GLASS PRIVACY RATING

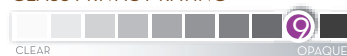

OPTIONS

Barcelona	0836	2236	0848	2248	0764	2264
Wrought Iron	■	■	■	■	■	■

FLORENCE WROUGHT IRON

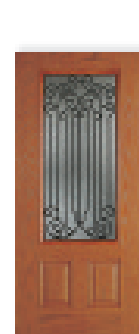

501-2248



501-764 501-2264
with matching Transom

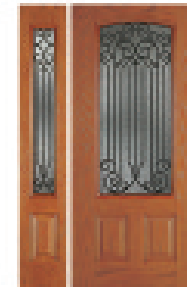

501-848 501-2248C

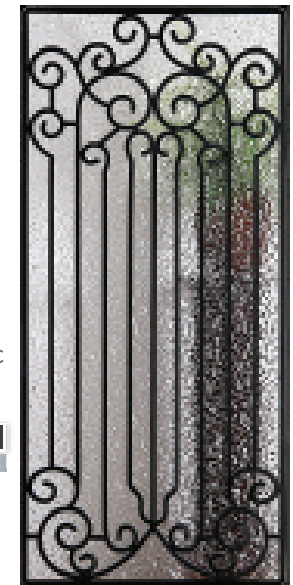

GLASS PRIVACY RATING



OPTIONS

Florence	2248	848	2248C	2264	764
Wrought Iron	■	■	■	■	■

PALERMO WROUGHT IRON



502-880 502-2280

502-848 502-2248

502-836 502-2236

OPTIONS

Palermo	0836	2236	0848	2248	0764	2264	0880	2280
Wrought Iron	■	■	■	■	■	■	■	■

GLASS PRIVACY RATING



VALENZIA WROUGHT IRON



503-880 503-2280

503-848 503-2248

503-836 503-2236

OPTIONS

Valencia	0836	2236	0848	2248	0764	2264	0880	2280
Wrought Iron	■	■	■	■	■	■	■	■

GLASS PRIVACY RATING



COMMODITY GLASS COLLECTION

INSERTS



200
LoE GLASS



210
LoE-INTERNAL GRILL



220
LoE INTERNAL BLINDS



230
LoE VENTING



240
LoE VENTING
INTERNAL GRILL

You can choose from many styles of door lites and nine styles of grilles that can be inside the door lite for maintenance free styling. All of our commodity lite options are made using LoE high performance tempered glass for safety and security.

EXECUTIVE PANELS

Window City offers several styles of 'Executive Panels' for your doors to give you a distinctive look. Each one is manufactured from a single piece of steel and is pre-painted on the outside and insulated with HCFC-free urethane on the inside.

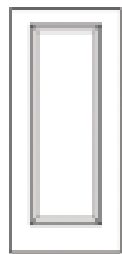

EX101



EX102

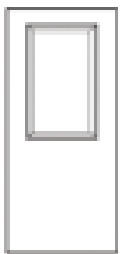

EX103



EX104

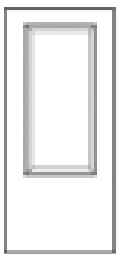

EX105



EX106

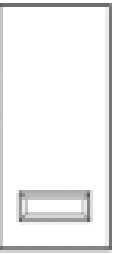

EX108

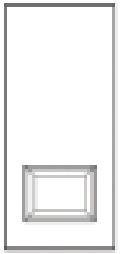

EX109

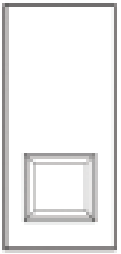

EX110

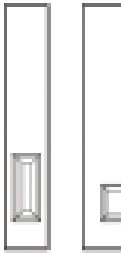

EX111

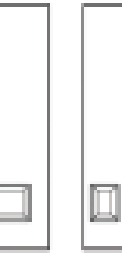

EX112



EX113

Code	EX101	EX102	EX103	EX104	EX105	EX106	EX108	EX109	EX110	EX111	EX112	EX113
Size	2264	764	2236	836	2248	848	2209	2217	2221	821	2211	811





PAINT OPTIONS

STANDARD PAINT COLOURS

■ For windows and doors (Steel, Smooth and Textured Fiberglass)

									
COLOUR	White	Ivory	Sandalwood	Sandstone	Brown	Classic Burgundy	Dark Bronze	Fiddlehead Green	Black Iron
CODE	WCP01	WCP02	WCP03	WCP04	WCP05	WCP06	WCP07	WCP08	WCP09
									
COLOUR	Peale Green	Tawny Rose	Dark Beige	Brick Red	Normandy	Stone Harbour	Deep Royal Blue	Barren Plain	Sandy White
CODE	WCP10	WCP11	WCP12	WCP13	WCP14	WCP15	WCP16	WCP17	WCP18

Actual paint colours may vary from printed samples.

WINDOW HARDWARE OPTIONS

CASEMENT & AWNING

Our Premium hardware system for our window collections offer several finishes and the low profile nesting handle adds elegance to your windows. The Premium Hardware is available with 8 finish options to fully customize your window selections.



White (Standard)



Coppertone



Bright Brass



Western Pewter



Brushed Brass



Antique Brass



Bright Chrome



Brushed Chrome

SINGLE & DOUBLE HUNG AND SLIDER

HARDWARE FOR HERITAGE COLLECTION WINDOWS



White (Standard)



Bright Brass



Western Pewter



Brushed Brass



Antique Brass



Bright Chrome



Brushed Chrome

Flush mounted cam locks and tilt latches.

HARDWARE FOR CLASSIC COLLECTION

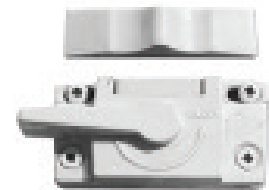

Tilt Latch

Cam Lock

GRILLE OPTIONS FOR WINDOWS & DOORS



Colonial

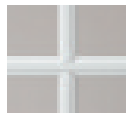

Georgian
5/8"



Georgian
1"



Pencil



V-Groove



SDL 3/4"

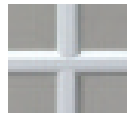

SDL 1"



Beveled Glass



Ferro - Z1



Infinito - Z2

ULTRA PATIO DOOR SLIDING COLLECTION HARDWARE OPTIONS

The standard Twin-Point hardware will add another element of beauty and security along with exceptional durability on all four finish options. The exterior keyed lock option is also available in all four finishes.



All hardware available with key lock



ULTRA PATIO DOOR SWING COLLECTION & ENTRY DOOR COLLECTION HARDWARE OPTIONS

HARDWARE / MULTIPOINT AUTOMATIC LOCK (LEVER SET HANDELS)

Our 12" long hardware is available in three finishes:
Black, Satin Nickel and Antique Brass

Swing Door Grip Set Handles 18"



Interior Exterior
Expression
Satin Nickel Finish

Interior Exterior
True Elegance
Black Finish

Berkeley

Salem

Our 9" long hardware is available in the Capri, Torino, Venice or Allegro Series lever set style and are offered in four elegant finish options. The Venice series is standard while the other series may require longer delivery time. Your doors will function and perform beautifully for years to come with our automatic locking system.

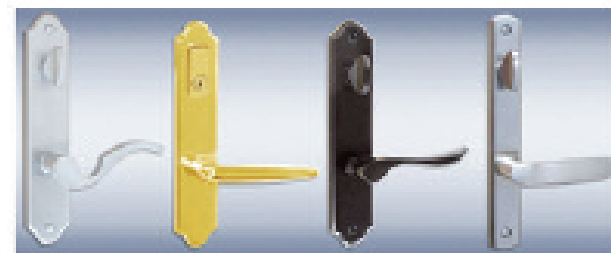

Capri Series Torino Series Venice Series (Standard) Allegro Series



CANADA'S MOST TRUSTED MANUFACTURER OF WINDOWS AND DOORS



Heritage
COLLECTION



Heritage Plus
COLLECTION



Heritage Maximum
COLLECTION

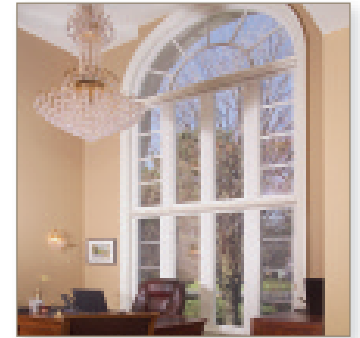

Classic
COLLECTION

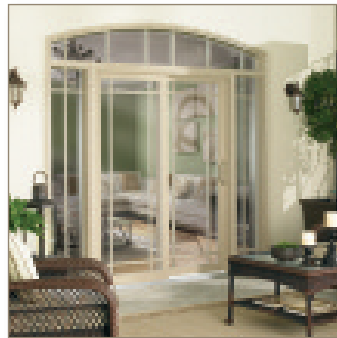

Ultra
Patio Door
SLIDING COLLECTION



Ultra
Patio Door
SWING COLLECTION

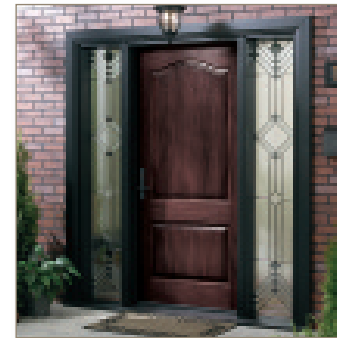

Lifetime
Entry Door
COLLECTION



Classic
Entry Door
COLLECTION

Window City Industries Inc.

5690 Steeles Avenue West. Vaughan, Ontario L4L 9T4
1.800.382.5020 www.windowcity.com



Non-Prorated Lifetime Warranty
For complete warranty information visit
windowcity.com

Window City Authorized Dealer

